

## YDS-M9K-MT9M114 V3.0

### 1.3MP OnSemi MT9M114 DVP Parallel Interface Fixed Focus Camera Module

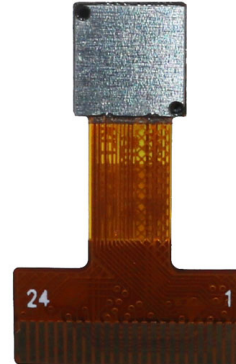

Front View



Back View

#### Specifications

Camera Module No.	YDS-M9K-MT9M114 V3.0
Resolution	1.3MP
Image Sensor	MT9M114
Sensor Type	1/6"
Pixel Size	1.9 um x 1.9 um
EFL	2.00 mm
F.NO	2.40
Pixel	1296 x 976
View Angle	75.0°(DFOV) 60.0°(HFOV) 47.0°(VFOV)
Lens Dimensions	6.00 x 6.00 x 3.54 mm
Module Size	19.50 x 12.50 mm
Module Type	Fixed Focus
Interface	DVP Parallel
Auto Focus VCM Driver IC	None
Lens Model	YDS-LENS-TR311B-H211-BD
Lens Type	650nm IR Cut
Operating Temperature	-30°C to +70°C
Mating Connector	FH12-24S-0.5SH



## YDS-M9K-MT9M114 V3.0 1.3MP OnSemi MT9M114 DVP Parallel Interface Fixed Focus Camera Module



Top View



Side View



Bottom View

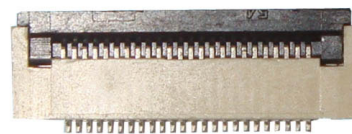

Mating Connector

# ROHS

## PIN SIGNAL

1	FLASH
2	AGND
3	SIO_D
4	AVDD 2.8V
5	SIO_C
6	NC
7	VSYNC
8	PWMD
9	HREF
10	NC
11	DOVDD1.8V
12	D7
13	XCLK
14	D6
15	DGND
16	D5
17	PCLK
18	D4
19	D0
20	D3
21	D1
22	D2
23	DGND
24	DGND

Version	Information	Date
V1.0	First Version	2017-11-22
V2.0	Update the PIN 1 and lens holder	2017-12-13
V3.0	Change lens and holder	2020-5-13

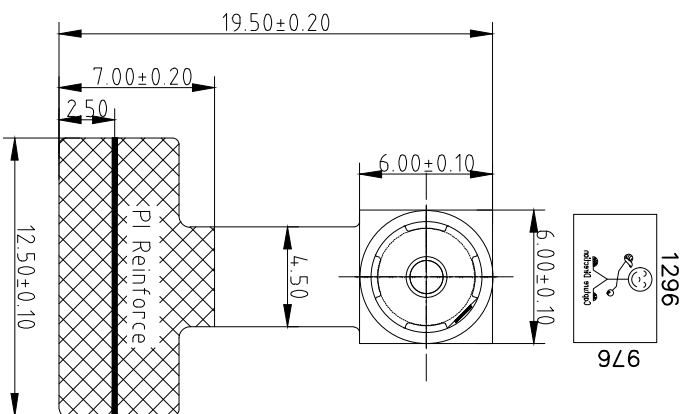

TOP VIEW

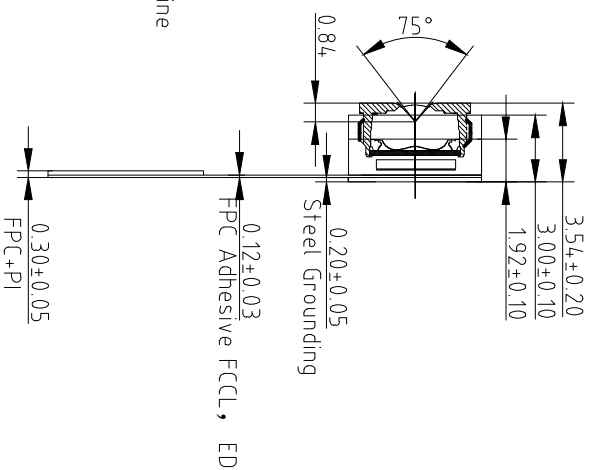

SIDE VIEW

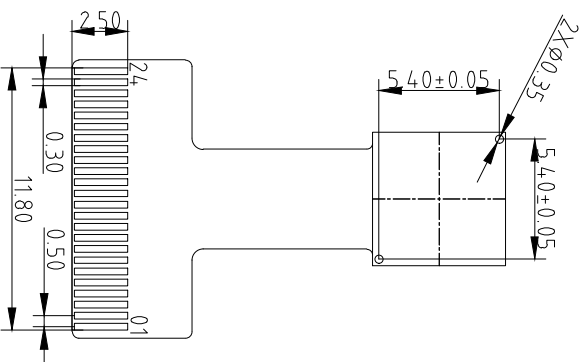

BOTTOM VIEW

### Parameters:

#### 1、Sensor specification:

Image Sensor: MT9M114  
 Pixel: 1.9umx1.9um  
 Lens Type: 1/6  
 Important Voltage Description: DVDD1.8V

#### 2、Lens specification:

FOV: 75°(D);60°(H);47°(V);  
 F/NO.: 2.4  
 TV distortion: <1.5%  
 Focal length: 2.0mm  
 Composition: 3P+IR FILTER  
 IR Cut Coating: 650nm±10nm@50%

Designed By

Kevin

Model Name:

M9K-MT9M114 V3.0

Checked By

Aouly Yan

Projection Type:  
 Third Angle

Unit: mm  
 Scale: 1:1

Material: -----  
 Sheet: 1 of 1

Version: 1/0

A

B

C

D

E

## Product Overview

### MT9M114: 1 MP 1/6" System-on-Chip

For complete documentation, see the data sheet.

ON Semiconductor's focus on pixel performance excellence enables the built-in advantages of having a high quality image sensor at the core of this SOC (System-on-Chip). ON Semiconductor's SOC's provide a variety of camera functions including auto focus, auto white balance, and auto exposure. SOC is a cost-effective, compact, one-chip solution providing exceptional image quality and ease of integration which can lower overall system costs and speed time to market.

### Applications

- Mobile

### Part Electrical Specifications

Product	Compliance	Status	Type	Megapixels	Frame Rate (fps)	Optical Format	Shutter Type	Pixel Size (µm)	Output Interface	Color	Package Type
MT9M114EBLSTCZ-CR	Pb-free Halide free	Active	CMOS	1.3	30	1/6 inch	Electronic Rolling	1.9 x 1.9	Parallel MIPI	RGB	ODCSP-55
MT9M114EBLSTCZ-CR1	Pb-free Halide free	Active	CMOS	1.3	30	1/6 inch	Electronic Rolling	1.9 x 1.9	Parallel MIPI	RGB	ODCSP-55

For more information please contact your local sales support at [www.onsemi.com](http://www.onsemi.com).

Created on: 9/30/2017

# MT9M114

## 1/6-inch 720p High-Definition (HD) System-On-a-Chip (SOC) Digital Image Sensor

The MT9M114 from ON Semiconductor is a 1/6-inch 1.26 Mp CMOS digital image sensor with an active-pixel array of 1296 (H) × 976 (V). It includes sophisticated camera functions such as auto exposure control, auto white balance, black level control, flicker avoidance, and defect correction. It is designed for low light performance. The MT9M114 produces extraordinarily clear, sharp digital pictures, making it the perfect choice for a wide range of applications, including mobile phones, PC and notebook cameras, and gaming systems.

**Table 1. KEY PERFORMANCE PARAMETERS**

Parameter	Typical Value
Optical Format	1/6-inch
Active Pixels	1296 (H) × 976 (V) = 1.26 Mp
Pixel Size	1.9 μm × 1.9 μm
Color Filter Array	RGB Bayer
Shutter	Electronic Rolling Shutter (ERS)
Input Clock Range	6–54 MHz
Output MIPI Data Rate Maximum	768 Mb/s
Max. Frame Rate	30 fps Full Res 36.7 fps 720p 75 fps VGA 120 fps QVGA (Note 2)
Responsivity	2.24 V/Lux–sec (550 nm)
SNR <sub>MAX</sub>	37 dB
Dynamic Range	70.8 dB
Supply Voltage	
Digital	1.7–1.95 V
Analog	2.5–3.1 V
I/O	1.7–1.95 V or 2.5–3.1 V
PLL	2.5–3.1 V
PHY	1.7–1.95 V
Power Consumption	135 mW (Note 1)
Operating Temperature Range (Ambient) – T <sub>A</sub>	–30°C to 70°C
Chief Ray Angle	27.7°
Active Imager Size	2.46 mm (H) × 1.85 mm (V), 3.08 mm Diagonal
Package Options	Bare Die, CSP

1. Power consumption for typical voltages and 720p output.
2. Reduced FOV.

### Features

- Superior Low-light Performance
- Ultra-low Power
- 720p HD Video at 30 fps



**ON Semiconductor®**

[www.onsemi.com](http://www.onsemi.com)

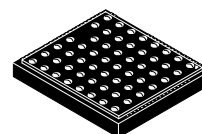

**ODCSP55 4.7x3.9  
CASE 570BP**

### ORDERING INFORMATION

See detailed ordering and shipping information on page 2 of this data sheet.

- Internal Master Clock Generated by On-chip Phase-locked Loop (PLL) Oscillator
- Electronic Rolling Shutter (ERS), Progressive Scan
- Integrated Image Flow Processor (IFP) for Single-die Camera Module
- Automatic Image Correction and Enhancement
- Arbitrary Image Scaling with Anti-aliasing
- Two-wire Serial Interface Providing Access to Registers and Microcontroller Memory
- Selectable Output Data Format: YCbCr, 565RGB, 555RGB, 444RGB, Processed Bayer, BT656, RAW8- and RAW8+2-bit
- Parallel and MIPI Data Output
- Independently Configurable Gamma Correction
- Adaptive Polynomial Lens Shading Correction
- UVC Interface
- Perspective Correction
- Multi-camera Synchronization

### Applications

- Embedded Notebook, Netbook, and Desktop Monitor Cameras
- Tethered PC Cameras
- Game Consoles
- Cell Phones, Mobile Devices, and Consumer Video Communications
- Surveillance, Medical, and Industrial Applications

## YDS-LENS-TR311B-H211-BD

**模号**

**SPECIFICATION**

**OPTICAL SPEC:**

1. COMPOSITION: 3P+IR (2M) ;
2. MATCH SENSOR: (1/5)
3. MAX IMAGE CIRCLE:  $\phi 3.9\text{mm}$ ;
4. EFL= 2.9mm;
5. F/NO= 2.4 ;
6. MAX. FOV: Horizontal 72.1° ( $\gamma^\circ = 1.44\text{mm}$ )  
Vertical 57° ( $\gamma^\circ = 1.08\text{mm}$ )  
Diagonal 84° ( $\gamma^\circ = 1.75\text{mm}$ )
7. MAX. CRA: 30.8°
8. TV-DISTORTION < 1.5%;
9. RELATIVE ILLUMINATION = 30% ( $\gamma^\circ = 1.75\text{mm}$ )

REV.	DATE	CHANGING	CLASS
①	2017.5.16	First draft	Using
②			
③			
④			

Approving	Checking	Designing
-----------	----------	-----------

# 0.5mm and 1mm Pitch Connectors For FPC/FFC

## FH12 Series

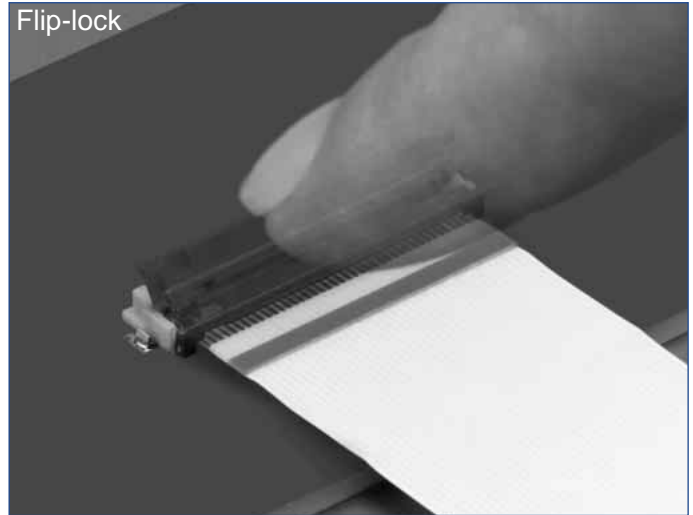
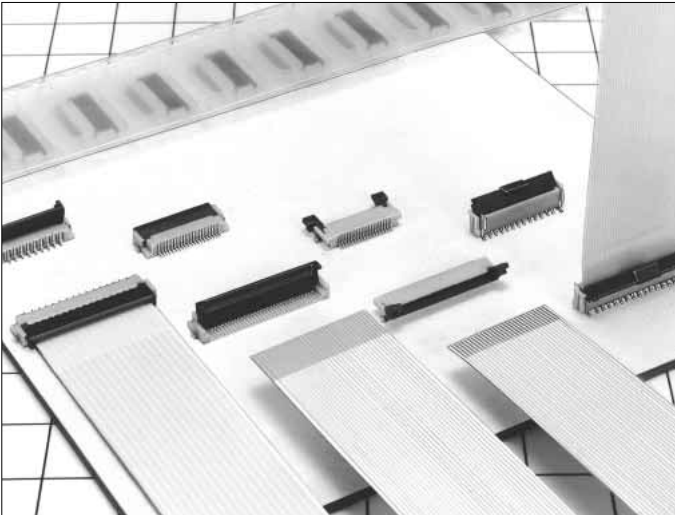

### ■ Features

#### 1. Ease of Use and Space Savings

Only one finger or 6.9N (Newtons) of force is required to lock Hirose's rotational actuator (flip-lock) as compared to using 2 fingers and 39.2N to close a FFC/FPC connector from our competition.

The Flip-Lock design also allows customers to place 2 or more connectors side by side as there is no need to waste additional board space for a side latch.

#### 2. Strengthened Flip-lock Actuator

The standard Flip-Lock requires only 2.0mm height above the board. A strengthened lock lever is available which only requires an additional 0.4mm.

#### 3. Supports Thin FPC (0.18mm)

Hirose does not require double-sided FPC to have any additional strengthening plate or stiffener and can therefore support a thickness of as little as 0.18mm +/- 0.05.

#### 4. Hirose Ensures Reliability

Hirose's patented half tuning fork contacts maintain the required normal force without relying on the connector housing. With our competitor's conventional products the housing walls support the contact force, which does not provide for long-term reliability.

#### 5. Prevention of Solder Bridge

Excess solder cavity absorbs excessive solder and avoids solder bridging.

#### 6. Three different assembly types

FH12 is offered in Top & Bottom Contact and Vertical Mount and offered in both a 0.5mm contact pitch as well as a 1.0mm contact pitch (bottom contact only).

### ■ Applications

Notebook computers, printers, PDAs, digital cameras and other compact devices for interconnecting the main circuit board with the LCD, HDD or other device.

### Rotating One-touch Mechanism

①

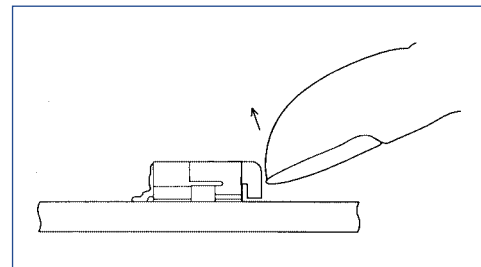

②

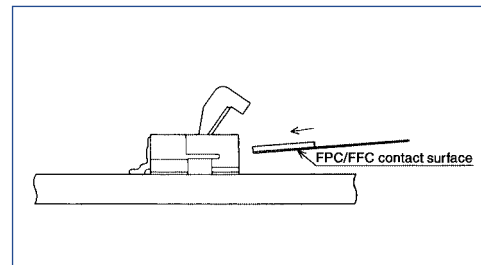

③

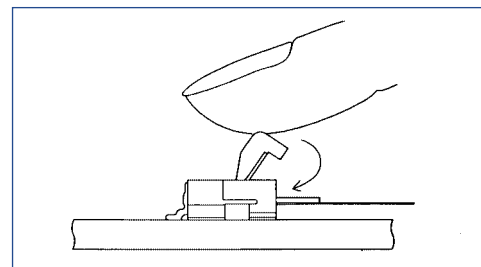

## Product Specifications

Rating	Current rating: 0.5A DC(Note 1)	Operating Temperature Range: -40 to +70°C (Note 2)	Storage Temperature Range: -10 to +50°C (Note 3)
	Voltage rating: 50V AC	Operating Humidity Range: Relative humidity, 90% max. (Not dewed)	Storage Humidity Range: Relative humidity, 90% max. (Not dewed)

Applicable FPC	t=0.3±0.05 Gold plated	t=0.18 ± 0.05 for FH12F-*S-0.5SH
----------------	------------------------	----------------------------------

Item	Specification	Conditions
1. Insulation resistance	500M ohms minimum	100V DC
2. Withstanding voltage	No flashover or insulation breakdown.	150V AC/1 minute
3. Contact resistance	50m ohms maximum	1mA
4. Durability (Insertion/withdrawal)	Contact resistance: 50m ohms maximum No damage, cracks, or parts dislocation.	20 cycles
5. Vibration	No electrical discontinuity of 1μs or more Contact resistance: 50m ohms maximum. No damage, cracks, or parts dislocation.	Frequency: 10 to 55 Hz, single amplitude of 0.75 mm, 2 hours in each of the 3 directions.
6. Shock	No electrical discontinuity of 1μs or more Contact resistance: 50m ohms maximum. No damage, cracks, or parts dislocation.	Acceleration of 490 m/s <sup>2</sup> , 11 ms duration, sine half-wave waveform, 3 cycles in each of the 3 axis.
7. Humidity(Steady state)	Contact resistance: 50m ohms maximum. Insulation resistance: 50M ohms minimum. No damage, cracks, or parts dislocation.	96 hours at 40°C and humidity of 90% to 95%
8. Temperature Cycle	Contact resistance: 50m ohms maximum. Insulation resistance: 50M ohms minimum. No damage, cracks, or parts dislocation.	Temperature: -40°C → 15 to 35°C → 85°C → 15 to 35°C, Time: 30 → 5 max. → 30 → 5 max.(minutes) 5 cycles
9. Resistance to Soldering heat	No deformation of components affecting performance.	Reflow: At the recommended temperature profile Manual soldering: 350±5°C for 3 seconds

Note 1: When passing the current through all of the contacts, use 70% of the current rating.

Note 2: Includes temperature rise caused by current flow.

Note 3: The term "storage" refers to products stored for long period of time prior to mounting and use. Operating Temperature Range and Humidity range covers nonconducting condition of installed connectors in storage, shipment or during transportation.

## Material

Part	Material	Finish	Remarks
Insulator	Polyamide, LCP(60 pos.)	Color : Beige	UL94V-0
Actuator	PPS	Color : Dark brown	
Contact	Phosphor bronze	Gold plated	
Metal Fittings	Brass	Tin plated	

## Ordering Information

**FH12**    **A** - **10** (**4**) - **S** **A** - **0.5** **SH** (**55**)  
 ①            ②            ③            ④            ⑤            ⑥            ⑦            ⑧            ⑨

① Series Name : FH12	⑤ Contact alignment: Single
② Blank : standard type A : Top contact type S : Type with strengthened flip-lock actuator F : Type with 0.18mm FPC End Thickness	⑥ Eccentric direction: Blank : standard type A : Eccentric type
③ Standard type : Number of contacts Eccentric type : Number of contacts in 0.5mm housing	⑦ Contacts Pitch : 0.5mm, 1mm
④ Standard type : Blank Eccentric type : Number of contacts	⑧ Contact type SH : SMT horizontal mounting type SV : SMT vertical mounting type
	⑨ Plating specification (55) : Gold plated



**FH12 Series 0.5mm and 1mm Pitch Connectors For FPC/FPC**

**Series Configuration**

Pitch	Bottom Contact Type	Top Contact Type	Vertical mounting Type
0.5mm	 <p><b>FH12- ** S-0.5SH</b> <b>P.12</b>                      Number of contacts 6, 8, 10, 11, 12, 13, 14, 15, 16, 17, 18, 19, 20, 22, 24, 25, 26, 28, 30, 32, 33, 34, 35, 36, 40, 45, 50, 53</p>		
	Type with Strengthened Lock Lever		
	<p><b>FH12S- ** S-0.5SH</b> <b>P.13</b>                      Number of contacts 30, 40, 45, 50, 53</p>		
	Type with 0.18mm FPC End Thickness		
	<p><b>FH12F- ** S-0.5SH</b> <b>P.14</b>                      Number of contacts 6, 8, 10, 12, 13, 14, 15, 16, 18, 20, 22, 24, 25, 26, 28, 30, 32, 34, 36, 40</p>		
1mm	 <p>Standard <b>FH12- ** S-1SH</b> <b>P.18</b>                      Eccentric <b>FH12- ** (***) SA-1SH</b>                      Standard                      Number of contacts 5, 6, 7, 8, 9, 11, 12, 16, 17, 22, 26                      Eccentric                      Number of contacts 4, 6, 8, 10, 11, 14, 19, 24</p>		 <p><b>FH12- ** S-1SV</b> <b>P.19</b>                      Number of contacts 6, 7, 8, 16, 20, 22, 24</p>

## 0.5mm Pitch Bottom Contact Type



Mated Cross-sectional Diagram

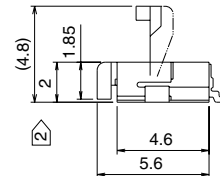
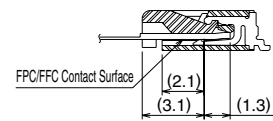

Unit:mm

Part Number	CL No.	Number of Contacts	A	B	C	D	RoHS
FH12- 6S-0.5SH(55)	586-0582-5-55	6	2.5	6.1	7.1	3.57	YES
FH12- 8S-0.5SH(55)	586-0744-5-55	8	3.5	7.1	8.1	4.57	
FH12-10S-0.5SH(55)	586-0522-3-55	10	4.5	8.1	9.1	5.57	
FH12-11S-0.5SH(55)	586-0600-5-55	11	5	8.6	9.6	6.07	
FH12-12S-0.5SH(55)	586-0704-0-55	12	5.5	9.1	10.1	6.57	
FH12-13S-0.5SH(55)	586-0549-0-55	13	6	9.6	10.6	7.07	
FH12-14S-0.5SH(55)	586-0533-0-55	14	6.5	10.1	11.1	7.57	
FH12-15S-0.5SH(55)	586-0523-6-55	15	7	10.6	11.6	8.07	
FH12-16S-0.5SH(55)	586-0531-4-55	16	7.5	11.1	12.1	8.57	
FH12-17S-0.5SH(55)	586-0606-1-55	17	8	11.6	12.6	9.07	
FH12-18S-0.5SH(55)	586-0530-1-55	18	8.5	12.1	13.1	9.57	
FH12-19S-0.5SH(55)	586-0534-2-55	19	9	12.6	13.6	10.07	
FH12-20S-0.5SH(55)	586-0524-9-55	20	9.5	13.1	14.1	10.57	
FH12-22S-0.5SH(55)	586-0532-7-55	22	10.5	14.1	15.1	11.57	
FH12-24S-0.5SH(55)	586-0521-0-55	24	11.5	15.1	16.1	12.57	
FH12-25S-0.5SH(55)	586-0692-3-55	25	12	15.6	16.6	13.07	
FH12-26S-0.5SH(55)	586-0576-2-55	26	12.5	16.1	17.1	13.57	
FH12-28S-0.5SH(55)	586-0612-4-55	28	13.5	17.1	18.1	14.57	
Note ② FH12-30S-0.5SH(55)	586-0525-1-55	30	14.5	18.1	19.1	15.57	
FH12-32S-0.5SH(55)	586-0681-7-55	32	15.5	19.1	20.1	16.57	
FH12-33S-0.5SH(55)	586-0520-8-55	33	16	19.6	20.6	17.07	
FH12-34S-0.5SH(55)	586-0617-8-55	34	16.5	20.1	21.1	17.57	
FH12-35S-0.5SH(55)	586-0740-4-55	35	17.0	20.6	21.6	18.07	
FH12-36S-0.5SH(55)	586-0526-4-55	36	17.5	21.1	22.1	18.57	
Note ② FH12-40S-0.5SH(55)	586-0527-7-55	40	19.5	23.1	24.1	20.57	
Note ② FH12-45S-0.5SH(55)	586-0528-0-55	45	22	25.6	26.6	23.07	
Note ② FH12-50S-0.5SH(55)	586-0529-2-55	50	24.5	28.1	29.1	25.57	
Note ② FH12-53S-0.5SH(55)	586-0595-7-55	53	26	29.6	30.6	27.07	

Note 1 : Embossed tape reel packaging (2,000 pieces/reel).  
 Order by number of reels.

Note ② : If there is no problem with the connector height, we recommend the type with the strengthened Flip-lock actuator (FH12S-\*S-0.5SH).  
 Standard type connector height: 2 mm  
 Connector height of type with strengthened Flip-lock actuator: 2.4 mm



# YDS CAMERA MODULE

*your best camera partner*

## Camera Module Pinout Definition Reference Chart

OmniVision	Sony	Samsung	On-Semi	Aptina	Himax	GalaxyCore	PixArt	SmartSens	Sensors
Pin Signal		Description							
DGND GND		ground for digital circuit							
AGND		ground for analog circuit							
PCLK DCK		DVP PCLK output							
XCLR PWDN XSHUTDOWN STANDBY		power down active high with internal pull-down resistor							
MCLK XVCLK XCLK INCK		system input clock							
RESET RST		reset active low with internal pull-up resistor							
NC NULL		no connect							
SDA SIO_D SIOD		SCCB data							
SCL SIO_C SIOC		SCCB input clock							
VSYNC XVS FSYNC		DVP VSYNC output							
HREF XHS		DVP HREF output							
DOVDD		power for I/O circuit							
AFVDD		power for VCM circuit							
AVDD		power for analog circuit							
DVDD		power for digital circuit							
STROBE FSTROBE		strobe output							
FSIN		synchronize the VSYNC signal from the other sensor							
SID		SCCB last bit ID input							
ILPWM		mechanical shutter output indicator							
FREQ		frame exposure / mechanical shutter							
GPIO		general purpose inputs							
SLASEL		I2C slave address select							
AFEN		CEN chip enable active high on VCM driver IC							
<b>MIPI Interface</b>									
MDN0 DN0 MD0N DATA_N DMO1N		MIPI 1st data lane negative output							
MDP0 DP0 MD0P DATA_P DMO1P		MIPI 1st data lane positive output							
MDN1 DN1 MD1N DATA2_N DMO2N		MIPI 2nd data lane negative output							
MDP1 DP1 MD1P DATA2_P DMO2P		MIPI 2nd data lane positive output							
MDN2 DN2 MD2N DATA3_N DMO3N		MIPI 3rd data lane negative output							
MDP2 DP2 MD2P DATA3_P DMO3P		MIPI 3rd data lane positive output							
MDN3 DN3 MD3N DATA4_N DMO4N		MIPI 4th data lane negative output							
MDP3 DP3 MD3P DATA4_P DMO4P		MIPI 4th data lane positive output							
MCN CLKN CLK_N DCKN		MIPI clock negative output							
MCP CLKP MCP CLK_P DCKN		MIPI clock positive output							
<b>DVP Parallel Interface</b>									
D0 DO0 Y0		DVP data output port 0							
D1 DO1 Y1		DVP data output port 1							
D2 DO2 Y2		DVP data output port 2							
D3 DO3 Y3		DVP data output port 3							
D4 DO4 Y4		DVP data output port 4							
D5 DO5 Y5		DVP data output port 5							
D6 DO6 Y6		DVP data output port 6							
D7 DO7 Y7		DVP data output port 7							
D8 DO8 Y8		DVP data output port 8							
D9 DO9 Y9		DVP data output port 9							
D10 DO10 Y10		DVP data output port 10							
D11 DO11 Y11		DVP data output port 11							

[www.YDSCAM.com](http://www.YDSCAM.com) [sales@ydscam.com](mailto:sales@ydscam.com) Phone (WeChat, QQ): (+86) 177 2732 6718

All rights reserved @ YingDeShun Co. Ltd. Specifications subject to change without notice.

## Cameras Applications



### IMAGING DEVICES



## Camera Reliability Test

Reliability Inspection Item		Testing Method	Acceptance Criteria	
Category	Item			
Environmental	Storage Temperature	High 60°C 96 Hours	Temperature Chamber	No Abnormal Situation
		Low -20°C 96 Hours	Temperature Chamber	No Abnormal Situation
	Operation Temperature	High 60°C 24 Hours	Temperature Chamber	No Abnormal Situation
		Low -20°C 24 Hours	Temperature Chamber	No Abnormal Situation
	Humidity	60°C 80% 24 Hours	Temperature Chamber	No Abnormal Situation
	Thermal Shock	High 60°C 0.5 Hours Low -20°C 0.5 Hours Cycling in 24 Hours	Temperature Chamber	No Abnormal Situation
Physical	Drop Test (Free Falling)	Without Package 60cm	10 Times on Wood Floor	Electrically Functional
		With Package 60cm	10 Times on Wood Floor	Electrically Functional
	Vibration Test	50Hz X-Axis 2mm 30min	Vibration Table	Electrically Functional
		50Hz Y-Axis 2mm 30min	Vibration Table	Electrically Functional
		50Hz Z-Axis 2mm 30min	Vibration Table	Electrically Functional
	Cable Tensile Strength Test	Loading Weight 4 kg 60 Seconds Cycling in 24 Hours	Tensile Testing Machine	Electrically Functional
Electrical	ESD Test	Contact Discharge 2 KV	ESD Testing Machine	Electrically Functional
		Air Discharge 4 KV	ESD Testing Machine	Electrically Functional
	Aging Test	On/Off 30 Seconds Cycling in 24 Hours	Power Switch	Electrically Functional
	USB Connector	On/Off 250 Times	Plug and Unplug	Electrically Functional



## Camera Inspection Standard

Inspection Item		Inspection Method	Standard of Inspection		
Category	Item				
Appearance	FPC/ PCB	Color	The Naked Eye	Major Difference is Not Allowed.	
		Be Torn/Chopped	The Naked Eye	Copper Crack Exposure is Not Allowed.	
		Marking	The Naked Eye	Clear, Recognizable (Within 30cm Distance)	
	Holder	Scratches	The Naked Eye	The Inside Crack Exposure is Not Allowed	
		Gap	The Naked Eye	Meet the Height Standard	
		Screw	The Naked Eye	Make Sure Screws Are Presented (If Any)	
		Damage	The Naked Eye	The Inside Crack Exposure is Not Allowed	
	Lens	Scratch	The Naked Eye	No Effect On Resolution Standard	
		Contamination	The Naked Eye	No Effect On Resolution Standard	
		Oil Film	The Naked Eye	No Effect On Resolution Standard	
		Cover Tape	The Naked Eye	No Issue On Appearance.	
	Function	Image	No Communication	Test Board	Not Allowed
			Bright Pixel	Black Board	Not Allowed In the Image Center
Dark Pixel			White board	Not Allowed In the Image Center	
Blurry			The Naked Eye	Not Allowed	
No Image			The Naked Eye	Not Allowed	
Vertical Line			The Naked Eye	Not Allowed	
Horizontal Line			The Naked Eye	Not Allowed	
Light Leakage			The Naked Eye	Not Allowed	
Blinking Image			The Naked Eye	Not Allowed	
Bruise			Inspection Jig	Not Allowed	
Resolution			Chart	Follows Outgoing Inspection Chart Standard	
Color			The Naked Eye	No Issue	
Noise			The Naked Eye	Not Allowed	
Corner Dark			The Naked Eye	Less Than 100px By 100px	
Color Resolution			The Naked Eye	No Issue	
Dimension	Height	The Naked Eye	Follows Approval Data Sheet		
	Width	The Naked Eye	Follows Approval Data Sheet		
	Length	The Naked Eye	Follows Approval Data Sheet		
	Overall	The Naked Eye	Follows Approval Data Sheet		

## YDSCAM Package Solutions

YDS Camera Module



Complete with Lens Protection Film



Tray with Grid and Space



Place Cameras on the Tray



## YDSCAM Package Solutions

Full Tray of Cameras



Cover Tray with Lid

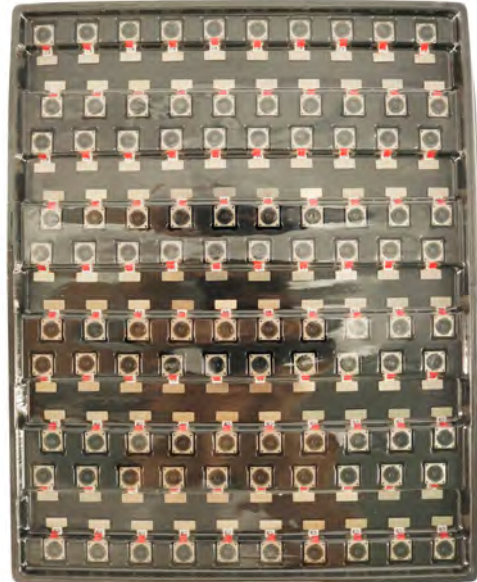

Place Tray into Anti-Static Bag



Vacuum the Anti-Static Bag





## YDSCAM Package Solutions

### Sealed Vacuum Anti-Static Bag with Labels

1. Model and Description 2. Quantity 3. Manufacturing Date Code 4. Caution



## YDSCAM Package Solutions

Place Foam Sheets Between Tray Bags



Foam Sheets are Larger Than Trays



Place Foam Sheets and Trays into Box



Foam Sheets are Tightly Fitting in Box



Seal the Carbon Box



Label the Carbon Shipping Box





## YDSCAM Package Solutions

USB Camera Module

Complete with Lens Protection Film



Place Camera Sample into Anti-Static Bag

Place USB Cameras into Tray



Seal the Tray with Anti-Static Bag

Label the Carbon Shipping Box



## YDSCAM Package Solutions

Place Camera Sample into Anti-Static Bag



Place Connectors into Anti-Static Bag



Label the Sample Bags



Place Connectors into Reel



Place Samples into the Carbon Box



Place Connectors into the Carbon Box





# YDS CAMERA MODULE

*your best camera partner*

## Company YDSCAM

YingDeShun Co. Ltd. (YDS) was established in 2017, a next-generation technology driven manufacturer specialized in research, design, and produce of audio and video products. YDS is occupying 20,000 square feet automated plants with 100 employees of annual throughput 30,000,000 units cameras.

YDS provides OEM, ODM design, contract manufacturing, and builds the camera products. You may provide the requirements to us, even with a hand draft, our sales and engineering work together to meet your needs. We consider ourselves your last-term partner in developing practical and innovative solutions.

Our team covers everything from initial concept development to mass produced product. YDS specializes in customized camera design, raw material, electronic engineering, firmware/software development, product testing, and packing design. Our experienced strategic supply systems offer a robust and dependable manufacturing capacity for orders of various sizes.



## Limited Warranty

YDS provides the following limited warranty if you purchased the Product(s) directly from YDS company or from YDS's website [www.YDSCAM.com](http://www.YDSCAM.com). Product(s) purchased from other sellers or sources are not covered by this Limited Warranty. YDS guarantees that the Product(s) will be free from defects in materials and workmanship under normal use for a period of one (1) year from the date you receive the product ("Warranty Period").

For all Product(s) that contain or develop material defects in materials or workmanship during the Warranty Period, YDS will, at its sole option, either: (i) repair the Product(s); (ii) replace the Product(s) with a new or refurbished Product(s) (replacement Product(s) being of identical model or functional equivalent); or (iii) provide you a refund of the price you paid for the Product(s).

This Limited Warranty of YDS is solely limited to repair and/or replacement on the terms set forth above. YDS is not reliable or responsible for any subsequent events.



[www.YDSCAM.com](http://www.YDSCAM.com) [sales@ydscom.com](mailto:sales@ydscom.com) Phone (WeChat, QQ): (+86) 177 2732 6718

All rights reserved @ YingDeShun Co. Ltd. Specifications subject to change without notice.



# YDS CAMERA MODULE

*your best camera partner*

## YDS Strength

### Powerful Factory



### Professional Service



### Promised Delivery



[www.YDSCAM.com](http://www.YDSCAM.com) [sales@ydscam.com](mailto:sales@ydscam.com) Phone (WeChat, QQ): (+86) 177 2732 6718

All rights reserved @ YingDeShun Co. Ltd. Specifications subject to change without notice.